



Signify

Canada 2 Day Quick Ship

Quick Ship

Lighting Guide

every
job matters

if

you want hard days
to feel a little easier

Choose Signify for great value, high performance
lighting brands that are ready to ship.

[signify.com/quickship](https://www.signify.com/quickship)

every
job matters

Content

Introduction	3	Architectural Lighting	6
Commitment	4	Office & Industrial Lighting	8
Definitions	86	High Bays	10
Brand Line Card	88	Linear	13
		Vaportite	17
		Recessed & Surface	19
		Indoor Track & Downlighting	26
		Downlights	28
		UniFrame Downlights	34
		LyteCaster Downlights	40
		LytePoints Downlights	46
		Track Lighting	48
		Commercial Outdoor Lighting	54
		Area & Canopy	56
		Floodlights	60
		Wallpacks	62
		Specialty	66
		Decorative Outdoor Lighting	68
		Low Voltage	69
		Connected Wireless Lighting	70
		Lamps	78

View the latest
version online at
[signify.com/quickship](https://www.signify.com/quickship)

Introduction

Introducing our latest Quick Ship guide (formerly known as Service Smart). This new guide has been revamped with an updated product mix that is designed to meet the day-to-day needs of your customers lighting projects.

All products listed are stocked and ready to ship in 2 days* from our Markham DC to ensure we can support your shelf-stocking requirements with reliable lead times. Choose from a wide variety of indoor or outdoor lighting solutions that deliver on performance, efficiency and budget.

We know that you face demanding timelines for your customers and our Quick Ship guide is your solution.

Day-Brite
CFI

LIGHTOLIER

KEENE

HADCO

interact

PHILIPS



* Service time is calculated from the time the order is entered until it is shipped, see page 4 for full details.

Commitment

Our delivery commitment is backed by a significant investment in finished goods and component inventory. If any unforeseen issues arise or if order volume exceeds maximum order quantity, we will do our best to meet your needs and confirm an acceptable ship date.

In case you have questions, please contact your sales representative or Customer Service.

Order Related Inquiries:

canada.om@signify.com / 1-800-668-9008

General Inquiries: 1-800-555-0050

Terms and Conditions

Freight Terms: Individual order minimum of \$1,000;
Shipping and handling fee for orders less than \$1,000.

Visit www.signify.com/en-ca/support/warranties for details on our standard terms and conditions.

Order Process

Lead time is from the time the order is entered and received by our warehouse. We are committed to entering orders within 24 hours of receipt.

To ensure your order is processed without delay, we recommend you verify you have the following:

- Correct Catalogue Numbers
- Price detail (Deal#, SPA reference)
- Tag "Quick Ship" on your order

Large Orders

To ensure we satisfy all our customers optimally within the committed lead times, maximum order quantities may apply. If the order exceeds the set threshold, Signify will contact you to work out a feasible schedule for your large order. It is always advised to work with your Signify representative to give advance notice of any foreseeable large orders.

Transportation timelines

Signify maintains stock levels of our luminaires at our warehouse in Markham, Ontario in order to provide our customers with quick access to the inventory you require. You can calculate when to expect your shipment by adding the following transportation times to the day it leaves our warehouse.

Toronto / Ottawa / Montreal	+1 Day
Windsor	+2 Days
Sudbury / Quebec City	+3 Days
Manitoba / New-Brunswick	+4 Days
Saskatchewan / Nova Scotia / P.E.I.	+5 Days
Alberta	+6 Days
British Columbia / Newfoundland	+7 Days





Architectural Lighting



Did you know that
Ledalite has a 10-day
QuickShip program?



ArcForm



VersaForm



ModiFly



FloatPlane



BoldPlay



PureFX



Vectra



Sync



Verge



Jump



SilkSpace



Shine



Sona



MicroSquare



Chopstick



TruGroove Suspended



TruGroove Recessed



TruGroove Recessed Micro



TruGroove Perimeter



TruGroove Cove

You don't have to sacrifice product quality and performance for critical timing. With the Ledalite QuickShip program, we'll ship your order within 10 working days of order receipt.

This program applies to almost all of our product families, so while we can't increase the speed of light, we did find a way to get you your lighting faster.

Category	Limit per Release
Recessed LED	100 units
Linear LED	500 linear ft.
TruGroove Family	

Order limits and exclusions apply. Contact your Ledalite sales rep for details. For more information please visit signify.com/en-ca/brands/ledalite/quickship



Day-Brite *CFI*

Office & Industrial Lighting





Day-Brite CFI is an industry leader in general purpose and performance lighting systems. With products ranging from high performance recessed ceiling troffers to industrial grade high bay luminaires, Day-Brite CFI's extensive portfolio offers the utmost in quality, and efficiency for a variety of applications.



High Bays



FBY



FCX



Catalogue Number	Description / Features		UPC
FBY LED High Bay			
FBY18L840-UNV	18000lm, 4000K (CRI 80), UNV	PREMIUM	784197653118
FBY18L840-UNV-WC6	18000lm, 4000K (CRI 80), UNV, Wired 6' 16/3 cord	PREMIUM	784197665548
FBY24L840-UNV	24000lm, 4000K (CRI 80), UNV	PREMIUM	784197653101
FBY24L840-UNV-WC6	24000lm, 4000K (CRI 80), UNV, Wired 6' 16/3 cord	PREMIUM	784197665562
FBY24L840-347	24000lm, 4000K (CRI 80), 347V	PREMIUM	784197665555
Accessories			
HNH5-VHOOK	54" Chain with V Hook		784197658762
HCH5-VHOOK	5' Cables with V Hook		784197658724
FBY-PENHGR	Pendant Hanger		784197665036
FBY-WG	2' Wire Guard		784197665579
FCX LED High Bay			
FCX15L840-UNV-DIM	15000lm, 4000K (CRI 80), UNV	PREMIUM	784197631895
FCX15L840-347-DIM	15000lm, 4000K (CRI 80), 347V	PREMIUM	784197635015
FCX22L840-UNV-DIM	22000lm, 4000K (CRI 80), UNV	PREMIUM	784197631871
FCX22L840-347-DIM	22000lm, 4000K (CRI 80), 347V	PREMIUM	784197635008



APX



HCX



SHE



Catalogue Number	Description / Features	UPC
APX LED High bay		
APX24LL40-UNV	24000lm, 4000K (CRI 80), UNV	• 784197056520
HCX LED High Bay		
HCX15L840-UNV-DIM	Round, 15000lm, 4000K (CRI 80), UNV	• 784197631840
HCX15L840-347-DIM	Round, 15000lm, 4000K (CRI 80), 347V	• 784197634926
HCX22L840-UNV-DIM	Round, 22000lm, 4000K (CRI 80), UNV	• 784197631833
HCX22L840-347-DIM	Round, 22000lm, 4000K (CRI 80), 347V	• 784197634872
SHE Fluorescent High Bay		
SHE454HO-UNV-1/4EB-GENRS-CORD	T5HO 54W (4 lamps), UNV, 6' Cord (no plug)	773849349943
SHE454HO-347-1/4EB-GENRS-CORD	T5HO 54W (4 lamps), 347V, 6' Cord (no plug)	773849349950
SHE654HO-UNV-1/42EB-GENRS-CORD	T5HO 54W (6 lamps), UNV, 6' Cord (no plug)	773849349929
SHE654HO-347-1/42EB-GENRS-CORD	T5HO 54W (6 lamps), 347V, 6' Cord (no plug)	773849349936

Linear



FSSEZ



FSS



Catalogue Number	Description / Features	UPC
FluxStream LED Strip EZ		
FSSEZ440L835-UNV	4', 4000lm, 3500K (CRI 80), UNV, Non-Dimmable	• 784197269982
FSSEZ440L840-UNV	4', 4000lm, 4000K (CRI 80), UNV, Non-Dimmable	• 784197245344
FSSEZ440L840-UNV-DIM	4', 4000lm, 4000K (CRI 80), UNV, 0-10V Dimming	784197665593
FSSEZ880L840-UNV	8', 8000lm, 4000K (CRI 80), UNV, Non-Dimmable	622252811052
FluxStream LED Strip		
FSS220L840-UNV-DIM	2', 2000lm, 4000K (CRI 80), UNV, 0-10V Dimming	• 784197245351
FSS330L840-UNV-DIM	3', 3000lm, 4000K (CRI 80), UNV, 0-10V Dimming	• 784197245375
FSS440L835-UNV-DIM	4', 4000lm, 3500K (CRI 80), UNV, 0-10V Dimming	• 784197270025
FSS440L840-347-DIM	4', 4000lm, 4000K (CRI 80), 347V, 0-10V Dimming	• 784197269869
FSS440L840-UNV-DIM	4', 4000lm, 4000K (CRI 80), UNV, 0-10V Dimming	• 784197245382
FSS455L840-UNV-DIM	4', 5500lm, 4000K (CRI 80), UNV, 0-10V Dimming	• 784197245405
FSS470L840-UNV-DIM	4', 7000lm, 4000K (CRI 80), UNV, 0-10V Dimming	• 784197245412
FSS8110L840-UNV-DIM	8', 11000lm, 4000K (CRI 80), UNV, 0-10V Dimming	• 784197245436
FSS880L840-347-DIM	8', 8000lm, 4000K (CRI 80), 347V, 0-10V Dimming	• 784197269906
FSS880L840-UNV-DIM	8', 8000lm, 4000K (CRI 80), UNV, 0-10V Dimming	• 784197245429



FSI



SCD



SLS



Catalogue Number	Description / Features	UPC
FluxStream LED Industrial		
FSI440L840-UNV-DIM	4', 4000lm, 4000K (CRI 80), UNV, 0-10V Dimming	• 784197245542
FSI880L840-UNV-DIM	8', 8000lm, 4000K (CRI 80), UNV, 0-10V Dimming	• 784197245580
FluxStream Accessories		
FSSWG4	4' Wire guard (order two for 8' models)	784197295028
FSTH	Sliding Hanger Bracket (Pair)	078197349707
SCD Wide Strip LED		
SCD220L840-UNV	2', 2000lm, 4000K (CRI 80), UNV, Non-dimmable	• 190096130146
SCD330L840-UNV	3', 3000lm, 4000K (CRI 80), UNV, Non-dimmable	190096130153
SCD428L840-UNV	4', 2800lm, 4000K (CRI 80), UNV, Non-dimmable	• 190096130160
SCD450L840-UNV	4', 5000lm, 4000K (CRI 80), UNV, Non-dimmable	• 190096130177
SLS Linkable Strip LED		
SLS216L840-UNV	2', 1600lm, 4000K (CRI 80), UNV, Non-dimmable	190096130191
SLS432L840-UNV	4', 3200lm, 4000K (CRI 80), UNV, Non-dimmable	190096130207



N Series



T Series



Catalogue Number	Description / Features	UPC
N Series Narrow T8 Strip		
N132-UNV-1/1-EB	4', 1 Lamp, T8 32W, Electronic Ballast, UNV	734340776195
CGS-4	N Strip 4' Wire Guard	782343296103
T Series T8 Strip		
T232-347-1/2-EB	4', 2 Lamp, T8 32W, Electronic Ballast, 347V	734340965681
T232-UNV-1/2-EB	4', 2 Lamp, T8 32W, Electronic Ballast, UNV	734340608328
TT232-347-1/4-EB	8', 4 Lamp, T8 32W, Electronic Ballast, 347V	734340965674
TT232-UNV-1/4-EB	8', 4 Lamp, T8 32W, Electronic Ballast, UNV	734340608342
Accessories		
CG-4	T Strip 4' Wire Guard	782343296059
FKR-126	Chain hanger set (pair)	782343184103
TIA232-UNV-1/4-EB	TIA Industrial uplight reflector, 8', T8 (4 lamps), UNV	734340608236
TIS232-UNV-1/4-EB	TIS Industrial Solid Reflector, 8', T8 (4 lamps), UNV	734340608250
FL-173	Wire Guard, Use w/ 1F Industrial, 2F Industrial, 1FD Industrial	782343296202



Vaportite



FSX



VTC



DW



V3W



Catalogue Number	Description / Features	ENERGY STAR	DLC LISTED	UPC
FluxStream LED Sealed Strip				
FSX440L840-UNV	4', 4000lm, 4000K (CRI 80), UNV, 0-10V Dimming			784197416102
VTC Sealed Strip LED				
VTC36L840-UNV	4', 3600lm, 4000K (CRI 80), UNV, Non-dimmable			190096130283
DW Vaporlume LED				
DWAE43L840-4-UNV	4', 4300lm, 4000K (CRI 80), UNV, Acrylic lens		PREMIUM	782343500712
V3W Vaporlume LED				
V3W443L840-UNV-DIM	4', 4300lm, 4000K (CRI 80), UNV, Acrylic lens		PREMIUM	784197426552
Vaporlume Accessories				
TBK	DWAE Stainless Steel Top Bracket Kit (pair of brackets plus hardware)			734340374599
WBK	Wall Bracket for V2/DW Vaporlume			781370485887



Recessed & Surface



FluxPanel

Catalogue Number	Description / Features	 	UPC
FluxPanel LED			
1×4'			
1FXP38B835-4-DS-UNV-DIM	3800lm, 3500K (CRI 80), UNV, 0-10V Dimming		• 784197381370
1FXP38L835-4-DS-UNV-DIM-IAP	3800lm, 3500K (CRI 80), UNV, 0-10V Dimming	interact ready.	• 784197642211
1FXP38B840-4-DS-UNV-DIM	3800lm, 4000K (CRI 80), UNV, 0-10V Dimming		• 784197381349
1FXP38L840-4-DS-UNV-DIM-IAP	3800lm, 4000K (CRI 80), UNV, 0-10V Dimming	interact ready.	• 784197642280
1FXP38L840-4-DS-347-DIM	3800lm, 4000K (CRI 80), 347V, 0-10V Dimming		• 784197695606
2×2'			
2FXP38B835-2-DS-UNV-DIM	3800lm, 3500K (CRI 80), UNV, 0-10V Dimming		• 784197381363
2FXP38L835-2-DS-UNV-DIM-IAP	3800lm, 3500K (CRI 80), UNV, 0-10V Dimming	interact ready.	• 784197642259
2FXP38B835-2-DS-347-DIM	3800lm, 3500K (CRI 80), 347V, 0-10V Dimming		• 190096130115
2FXP38B840-2-DS-UNV-DIM	3800lm, 4000K (CRI 80), UNV, 0-10V Dimming		• 784197381332
2FXP38L840-2-DS-UNV-DIM-IAP	3800lm, 4000K (CRI 80), UNV, 0-10V Dimming	interact ready.	• 784197642242
2FXP38B840-2-DS-347-DIM	3800lm, 4000K (CRI 80), 347V, 0-10V Dimming		• 190096130108



Catalogue Number	Description / Features		UPC
	2x4'		
2FXP42B835-4-DS-UNV-DIM	4200lm, 3500K (CRI 80), UNV, 0-10V Dimming		• 784197381356
2FXP42B835-4-DS-347-DIM	4200lm, 3500K (CRI 80), 347V, 0-10V Dimming		• 190096130092
2FXP42B840-4-DS-UNV-DIM	4200lm, 4000K (CRI 80), UNV, 0-10V Dimming		• 784197381325
2FXP42B840-4-DS-347-DIM	4200lm, 4000K (CRI 80), 347V, 0-10V Dimming		• 190096130085
2FXP43L835-4-DS-UNV-DIM-IAP	4300lm, 3500K (CRI 80), UNV, 0-10V Dimming	interact ready.	• 784197642228
2FXP43L840-4-DS-UNV-DIM-IAP	4300lm, 4000K (CRI 80), UNV, 0-10V Dimming	interact ready.	• 784197642235
2FXP48L840-4-DS-UNV-DIM	4800lm, 4000K (CRI 80), UNV, 0-10V Dimming		• 784197617653



FluxGrid



Catalogue Number	Description / Features		UPC
FluxGrid LED			
1×4'			
1FGG38L840-4-D-347-DIM	1×4', 3800lm, 4000K (CRI 80), 347V, 0-10V Dimming	•	784197269043
1FGG41B840-4-D-UNV-DIM	1×4', 4100lm, 4000K (CRI 80), UNV, 0-10V Dimming	•	784197242282
1FGG41B835-4-D-UNV-DIM	1×4', 4100lm, 3500K (CRI 80), UNV, 0-10V Dimming	•	784197203634
2×2'			
2FGG30L835-2-D-UNV-DIM	3000lm, 3500K (CRI 80), UNV, 0-10V Dimming	•	622252778089
2FGG38B835-2-D-UNV-DIM	3800lm, 3500K (CRI 80), UNV, 0-10V Dimming	•	784197203641
2FGG38B840-2-D-UNV-DIM	3800lm, 4000K (CRI 80), UNV, 0-10V Dimming	•	784197242268
2×4'			
2FGG38L835-4-D-UNV-DIM	3800lm, 3500K (CRI 80), UNV, 0-10V Dimming	•	622252783496
2FGG42B835-4-D-UNV-DIM	4200lm, 3500K (CRI 80), UNV, 0-10V Dimming	•	784197203658
2FGG42B840-4-D-UNV-DIM	4200lm, 4000K (CRI 80), UNV, 0-10V Dimming	•	784197242237
2FGG43L840-4-D-UNV-DIM-IAP	4300lm, 4000K (CRI 80), UNV, 0-10V Dimming	interact ready.	784197655457
2FGG48L835-4-D-UNV-DIM	4800lm, 3500K (CRI 80), UNV, 0-10V Dimming	•	784197242305
2FGG48L840-4-D-UNV-DIM	4800lm, 4000K (CRI 80), UNV, 0-10V Dimming	•	784197242220



TG8



OWL



OW



CFW



Catalogue Number	Description / Features	UPC
TG Troffer		
1TG8232-01-UNV-1/2-EB	1×4', 2 Lamp, T8 32W, UNV, Electronic Ballast, FS, Pattern 12 Prismatic	781370952631
2TG8432-01-347-1/4-EB	2×4', 4 Lamp, T8 32W, 347V, Electronic Ballast, FS, Pattern 12 Prismatic	734340962116
2TG8432-01-UNV-1/4-EB	2×4', 4 Lamp, T8 32W, UNV, Electronic Ballast, FS, Pattern 12 Prismatic	734340976595
Accessories		
FMA14	1×4' Drywall Flange Kit	734340775488
FMA22	2×2' Drywall Flange Kit	734340775471
FMA24	2×4' Drywall Flange Kit	734340775464
OWL Wraparound LED		
OWL440L835-UNV-DIM	4', 4000lm, 3500K (CRI 80), UNV, 0-10V Dimming	• 781370097219
OWL440L840-UNV-DIM	4', 4000lm, 4000K (CRI 80), UNV, 0-10V Dimming	• 781370049003
OW Wraparound		
OWN232-UNV-1/2-EB	4', 2 Lamp, T8 32W, UNV, Electronic Ballast	734340608281
CFW Wraparound		
CFW232-120-1/2EB-GENIS	4', 2 Lamp, T8 32W, 120V, Electronic ballast, Acrylic lens	773849355036



SlimLux



UPC

Catalogue Number	Description / Features		UPC
SlimLux LED	Lightbar		
SL1P02835NGW	2', 3500K (CRI 80), White	•	190096130061
SL1P02840NGW	2', 4000K (CRI 80), White	•	190096130047
SL1P04835NGW	4', 3500K (CRI 80), White	•	190096130023
SL1P04840NGW	4', 4000K (CRI 80), White	•	190096130009
	Driver Pods ¹		
SL04SG38LUNVDIM1	Driver Pod for 1: 4' Lightbar, 3800lm/4ft, UNV DIM ²	•	784197656027
SL04QG38LUNVDIM1	Driver Pod for 4: 4' Lightbars, 3800lm/4ft, UNV DIM	•	784197656010
SL04MG38LUNVDIM1	Driver Pod for 8: 4' Lightbars, 3800lm/4ft, UNV DIM ³	•	784197656034

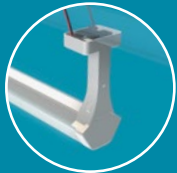

Easy-click method
for faster installation

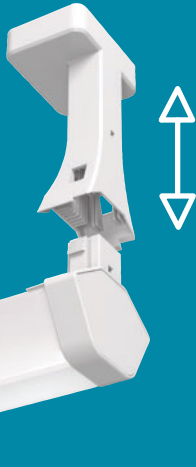

Driver pods include
integral clips for mounting
to T-bar above the ceiling



Quick Connects
to Light Bar

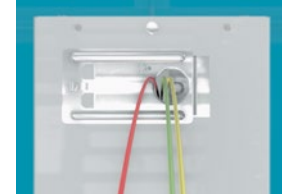

Quick Connect
to building mains

- Note that each Driver Pod is designed for the exact amount of lightbars.
For example: Q pod must be installed and operated with 4 lightbars.
- Single (S) driver pod is direct wire to lightbar.
Quad (Q) and Oct (M) driver pods include two-port push in wire connections.
- Oct (M) driver pod includes four connection ports on each side of splice box.



Step out of the recessed zone

Looking for a better T-Grid lighting solution than your budget, boring recessed troffer? Moving to an architectural solution is challenging because of the many limiting factors of these particular ceiling environments. Now we're making this easy with the Day-Brite CFI SlimLux LED luminaire, which provides high performance indirect lighting in a low profile suspended linear form factor that's really simple to install.

Learn more @ cfi-lighting.com/slimlux

LIGHTOLIER

**Indoor
Track &
Downlighting**





Lightolier is a global market leader widely recognized for its innovative LED lighting solutions with an unmatched commitment to technology leadership, reliability, visual appeal and high performance. The Lightolier comprehensive product offering provides you with a quick and easy way to select both downlighting and track lighting solutions that compliment every lighting application.



Downlights



FD

The Flat Downlight LED now features switch to choose colour temperature (2700K–5000K).



MD



MG



C2L

Catalogue Number	Description / Features	ENERGY STAR	DLC LISTED	UPC
Flat Downlight LED				
	120V, White			
FD4R4CCT	4" Round, 700lm, 2700K / 3000K / 4000K / 5000K (CRI 90)	•		784197681272
FD6R4CCT	6" Round, 900lm, 2700K / 3000K / 4000K / 5000K (CRI 90)	•		784197681289
Mini Downlight LED				
	3" Round, TRIAC Dimming			
MD3R069301FW	550lm, 3000K (CRI 90), Flood, White	•		190096017409
MD3R069401FW	550lm, 4000K (CRI 90), Flood, White	•		190096017416
Mini Gimbal LED				
	3" Round, TRIAC Dimming			
MG3R06930NF1W	550lm, 3000K (CRI 90), Narrow Flood, White	•		190096017270
MG3R06940NF1W	550lm, 4000K (CRI 90), Narrow Flood, White	•		190096017300
Mini Downlight / Mini Gimbal Accessories				
MDRN	New Construction Plate, 3" Round			190096017355
MD06C	6' Extension Cord			190096017331
MD20C	20' Extension Cord			190096017348
Calculite LED 1.75" Downlight, 900lm (Frame with Integral LED and optics only, trim sold separately*)				
C2L09DL930RZ10U	3000K (CRI 90), UNV, 0–10V Dimming	•		190096017126
C2L09DL930RE1	3000K (CRI 90), 120V, ELV Dimming	•		190096017164

* Trims need to be ordered separately for a complete luminaire [Frame + Trim or Micro Vetro (optional)]. Consult Signify Order Management team for delivery timeframe on trims.





SD



S5R / S7R



S4S / S6S

Catalogue Number	Description / Features	 	UPC
Surface Mount Downlight LED TRIAC / ELV Dimming			
SD5R079301W	5" Round, 700lm, 3000K (CRI 90), 120V, White	•	190096016426
SD7R099301W	7" Round, 1000lm, 3000K (CRI 90), 120V, White	•	190096016433
SlimSurface LED Round 5" Round, TRIAC / ELV Dimming			
S5R827K7	600lm, 2700K (CRI 80), 120V, White	•	662057988672
S5R927K7	600lm, 2700K (CRI 90), 120V, White	•	662057988702
S5R830K7	600lm, 3000K (CRI 80), 120V, White	•	662057936055
S5R835K7	600lm, 3500K (CRI 80), 120V, White	•	662057985480
S5R840K7	600lm, 4000K (CRI 80), 120V, White	•	662057985510
7" Round, TRIAC / ELV Dimming			
S7R827K10	900lm, 2700K (CRI 80), 120V, White	•	662057988726
S7R830K10	900lm, 3000K (CRI 80), 120V, White	•	662057988740
SlimSurface LED Square 4" Square, TRIAC / ELV Dimming			
S4S830K7	600lm, 3000K (CRI 80), 120V, White	•	662057988801
6" Square, TRIAC / ELV Dimming			
S6S830K10	900lm, 3000K (CRI 80), 120V, White	•	662057988863



RD



CR



The Commercial Retrofit Downlight LED features a **field adjustable lumen output switch**, which makes it an ideal solution for different ceiling heights in the same application.





UPC

Catalogue Number	Description / Features		UPC
Retrofit Downlight LED			
TRIAC / ELV Dimming			
RD4R089301W	4" Round, 800lm, 3000K (CRI 90), 120V, White	•	190096016389
RD5R129301W	5/6" Round, 1200lm, 3000K (CRI 90), 120V, White	•	190096016396
Commercial Retrofit Downlight LED			
4" Round, 500lm / 750lm / 1000lm			
CR4R10930UW	4" Round, 500lm / 750lm / 1000lm, 3000K (CRI 90)	•	190096017621
CR4R10935UW	4" Round, 500lm / 750lm / 1000lm, 3500K (CRI 90)	•	190096017638
CR4R10940UW	4" Round, 500lm / 750lm / 1000lm, 4000K (CRI 90)	•	190096017645
6" Round, 700lm / 1000lm / 1500lm			
CR6R15930UW	6" Round, 700lm / 1000lm / 1500lm, 3000K (CRI 90)	•	190096017669
CR6R15935UW	6" Round, 700lm / 1000lm / 1500lm, 3500K (CRI 90)	•	190096017676
CR6R15940UW	6" Round, 700lm / 1000lm / 1500lm, 4000K (CRI 90)	•	190096017683
8" Round, 1000lm / 1500lm / 2300lm			
CR8R23930UW	8" Round, 1000lm / 1500lm / 2300lm, 3000K (CRI 90)	•	190096017706
CR8R23935UW	8" Round, 1000lm / 1500lm / 2300lm, 3500K (CRI 90)	•	190096017713
CR8R23940UW	8" Round, 1000lm / 1500lm / 2300lm, 4000K (CRI 90)	•	190096017720
9.5" Round, 1500lm / 2000lm / 3200lm			
CR10R30930UW	9.5" Round, 1500lm / 2000lm / 3200lm, 3000K (CRI 90)	•	190096017744
CR10R30935UW	9.5" Round, 1500lm / 2000lm / 3200lm, 3500K (CRI 90)	•	190096017751
CR10R30940UW	9.5" Round, 1500lm / 2000lm / 3200lm, 4000K (CRI 90)	•	190096017768



CP4R

Catalogue Number	Description / Features	 	UPC
CorePro 4"			
Frame			
CP4RN	New Construction Housing, IC c/w LED Connector	•	662057939094
CP4RR	Remodeler Housing, IC c/w LED Connector	•	662057939100
LED 4" Round, 10% TRIAC Dimming			
CP4RB07830W	800lm, 3000K (CRI 80), 120V, White	•	662057939018
CP4RB07840W	800lm, 4000K (CRI 80), 120V, White	•	662057939025
CorePro 5"			
Frame			
CP5RN	New Construction Housing, IC c/w LED Connector	•	662057939117
CP5RR	Remodeler Housing, IC c/w LED Connector	•	662057939124
LED 5" Round, 10% TRIAC Dimming			
CP5RB08830W	950lm, 3000K (CRI 80), 120V, White	•	662057939049
CP5RB08840W	1000lm, 4000K (CRI 80), 120V, White	•	662057939056
CorePro 6"			
Frame			
CP6RN	New Construction Housing, IC c/w LED Connector	•	662057939131
CP6RR	Remodeler Housing, IC c/w LED Connector	•	662057939148
LED 6" Round, 10% TRIAC Dimming			
CP6RB10830W	1200lm, 3000K (CRI 80), 120V, White	•	662057939070
CP6RB10840W	1250lm, 4000K (CRI 80), 120V, White	•	662057939087





UniFrame Downlights

One frame for maximum flexibility

The **Lightolier UniFrame**, single frame solution architecture, is adaptable and designed around ever-changing project needs. Three unique downlight families all use this same frame. Your choices and flexibility are now endless.

- **Modular plug-and-play** receptacle enables quick and easy tool-free installation
- **Configurable solutions** mean installation can start sooner and be completed in stages
- **Future-proof** modular design allows easy upgrades without ceiling disturbance
- Unexpected design changes have **minimal schedule impact and waste**
- Option available for **Interact Pro wireless control**. For more information visit www.interact-lighting.com/pro

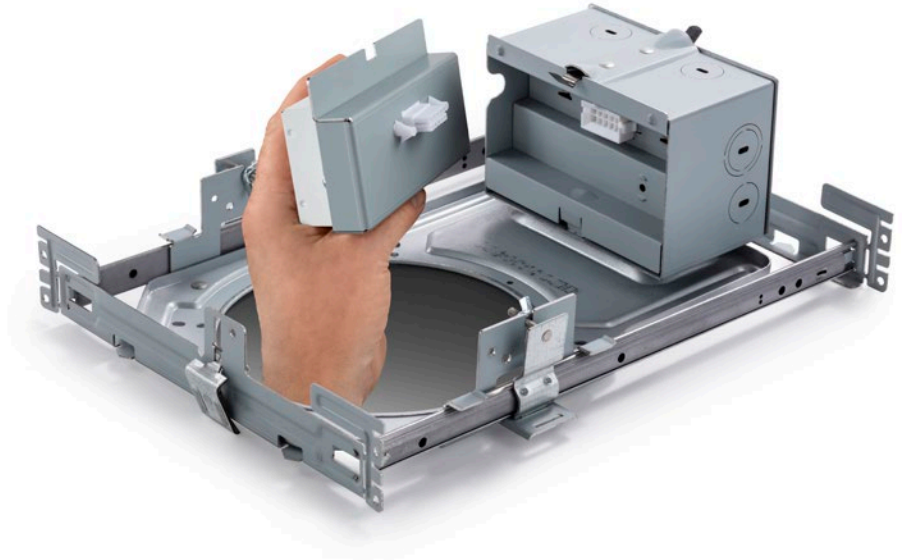

LyteProfile

Commercial
2-part system
(pg. 37-37)



EasyLyte

Light Commercial
2-part system
(pg. 38-38)





3RN



4RN



6RN

Catalogue Number	Description / Features	ENERGY STAR	DLC LISTED	UPC
UniFrame 3"				
3RN	3" Round, New Construction (Non-IC), UNV		•	784197666125
3RNIP	3" Round, New Construction (Non-IC), UNV	interact ready.	•	784197666132
3SN	3" Square, New Construction (Non-IC), UNV		•	784197666187
3SNIP	3" Square, New Construction (Non-IC), UNV	interact ready.	•	784197666194
UniFrame 4"				
4RN	4" Round, New Construction (Non-IC), UNV		•	784197641924
4RNIP	4" Round, New Construction (Non-IC), UNV	interact ready.	•	190096017515
4RR3	4" Round, Remodeler (Non-IC), 347V		•	784197211462
4SN	4" Square, New Construction (Non-IC), UNV		•	784197641955
UniFrame 6"				
6RN	6" Round, New Construction (Non-IC), UNV		•	784197641979
6RNIP	6" Round, New Construction (Non-IC), UNV	interact ready.	•	190096017553
6RR3	6" Round, Remodeler (Non-IC), 347V		•	784197211646
6SN	6" Square, New Construction (Non-IC), UNV		•	784197642006
Accessories				
1950	Mounting Bars 18" Set of (2) (Order in Multiples of 12)			784197145002
1951	Mounting Bars 27" Set of (2) (Order in Multiples of 12)			784197145033



P4RDL



P6RDL





Catalogue Number	Description / Features		UPC
LyteProfile LED 4"			
	LED 4" Round, Comfort Clear finish, White flange, 0-10V 1% Dimming, UNV		
P4RDL10830CCZ10U	1000lm, 3000K (CRI 80)	•	190096102570
P4RDL10835CCZ10U	1000lm, 3000K (CRI 80)	•	190096105441
P4RDL15830CCZ10U	1500lm, 3000K (CRI 80)	•	190096102600
P4RDL15835CCZ10U	1500lm, 3000K (CRI 80)	•	190096104406
P4RDL20830CCZ10U	2000lm, 3000K (CRI 80)	•	190096102624
P4RDL20835CCZ10U	2000lm, 3000K (CRI 80)	•	190096102631
LyteProfile LED 6"			
	LED 6" Round, Comfort Clear finish, White flange, 0-10V 1% Dimming, UNV		
P6RDL10830CCZ10U	1000lm, 3000K (CRI 80)	•	190096105755
P6RDL10835CCZ10U	1000lm, 3500K (CRI 80)	•	190096128211
P6RDL15830CCZ10U	1500lm, 3000K (CRI 80)	•	190096105816
P6RDL15835CCZ10U	1500lm, 3500K (CRI 80)	•	190096105823
P6RDL20830CCZ10U	2000lm, 3000K (CRI 80)	•	190096102716
P6RDL20835CCZ10U	2000lm, 3500K (CRI 80)	•	190096105885



Z4RDL



Z6RDL

Catalogue Number	Description / Features	 	UPC
EasyLyte LED 4"	LED 4" Round, Wide, Open downlight, Clear diffuse finish, 0-10V 1% Dimming, UNV		
Z4RDL10840W OCDZ10U	1000lm, 4000K (CRI 80)	•	190096106639
Z4RDL20835W OCDZ10U	2000lm, 3500K (CRI 80)	•	190096103119
Z4RDL20840W OCDZ10U	2000lm, 4000K (CRI 80)	•	190096106875
EasyLyte LED 6"	LED 6" Round, Open downlight, Clear diffuse finish, 0-10V 1% Dimming, UNV		
Z6RDL15840W OCDZ10U	1500lm, 4000K (CRI 80)	•	190096103157
Z6RDL20840W OCDZ10U	2000lm, 4000K (CRI 80)	•	190096103195





LyteCaster Downlights

Defining general purpose LED downlights

Lightolier LyteCaster LED downlight and accent luminaires provide comfortable, quality illumination. LyteCaster's shallow frame height fits into tight plenum spaces and the adaptable design makes it a versatile lighting option.

- The frame includes **90° swivel** mounting bar points and offset holes for applications close to joints for easy installation
- **Modular and innovative** light engine that's easy to install and upgrade
- **High efficacy** with up to 90 lm/W helps provide greater cost and energy savings
- **Wet location listed** with no need for special lens design

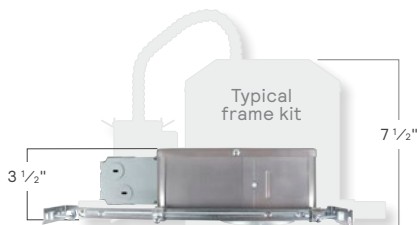

New Construction

LyteCaster LED Accent and Downlights share the same AirSeal IC rated frame that is 3 1/2" in height. The shallow height saves plenum space without compromising the physical and reflected cutoff.



Remodeler

A remodeler is available for accent and downlight in a shallow construction that is under 5 3/8". Accent is non-IC and downlight is IC/AirSeal rated.



Accent

3-part system

Downlight

3-part system



Housing



Light Engine



Adjustable Trim



Downlight Trim



Gimbal Trim

Catalogue Number	Description / Features	ENERGY STAR	DLC LISTED	UPC
LyteCaster 3" LED Accent				
Housing				
L3ANE1	New construction with nails (Non-IC), ELV/TRIAC Dimming, 120V	•		662057999333
L3CE1	Remodeler (Non-IC)*, ELV/TRIAC Dimming, 120V (*not compatible with adjustable trim)	•		662057999319
LED				
L308830F	800lm, 3000K (CRI 80), Flood (33°)	•		662057998053
L308830NF	800lm, 3000K (CRI 80), Narrow Flood (22°)	•		662057998015
L308835F	800lm, 3500K (CRI 80), Flood (33°)	•		662057998138
L308835NF	800lm, 3500K (CRI 80), Narrow Flood (22°)	•		662057998121
Trim Round				
L3RAW	Adjustable, White Cone with white flange			662057997674
L3RDD	Downlight, Diffuse Cone with white flange			662057997629
L3RGA	Gimbal, Aluminum			662057997841
L3RGW	Gimbal, White			662057997827
Accessories				
0089L	New Construction Plate, 3" Round (Long)			624563160072
0089S	New Construction Plate, 3" Round (Short)			624563107695



Housing



LED



L4RDD



L4RDW

Catalogue Number	Description / Features	ENERGY STAR	DLC LISTED	UPC
LyteCaster 4" LED				
Housing				
L4RANZ10UVA	New construction with nails (Airseal IC), 0-10V Dimming, UNV, Version A	•		662057941769
L4RANE1VA	New construction with nails (Airseal IC), ELV, 120V, Version A	•		662057941653
LED				
L4R06830VA	650lm, 3000K (CRI 80), Version A	•		662057998725
L4R06835VA	650lm, 3500K (CRI 80), Version A	•		662057998749
Trim Round				
L4RDD	Downlight, Clear diffuse with white flange			662057993706
L4RDW	Downlight, White with white flange			662057993713
Accessories				
0092L	New Construction Plate, 4" Round (Long)			624563159977
0092S	New Construction Plate, 4" Round (Short)			624563107701



Housing





LED



L5RDD



L5RDW

Catalogue Number	Description / Features	 	UPC
LyteCaster 5" LED			
Housing			
L5RANZ10UVA	New construction with nails (Airseal IC), 0-10V Dimming, UNV, Version A	•	662057941714
L5RANE1VA	New construction with nails (Airseal IC), ELV, 120V, Version A	•	662057941707
LED			
L5R10830VA	1000lm, 3000K (CRI 80), Version A	•	662057941103
L5R10835VA	1000lm, 3500K (CRI 80), Version A	•	662057941110
Trim Round			
L5RDD	Downlight, Clear diffuse with white flange		662057993843
L5RDW	Downlight, White with white flange		662057993850
LyteCaster 5"			
Housing			
1004ICN	Lytene New Construction IC & Non-IC Housing Nail		784197198596
1004ICR	Lytene Remodeler IC & Non-IC Housing Screw		784197159320
Trim			
1076CH	Basic Specular Cone Chrome Reflector		662057672120
1076WH	Basic White Baffle		784197107604



Housing



LED



L6RDW



L6RDD



L6RDW

Catalogue Number	Description / Features	ENERGY STAR	DLC LISTED	UPC
LyteCaster 6" LED				
Housing				
L6RANZ10UVA	New construction with nails (Airseal IC), 0-10V Dimming, UNV, Version A	•		662057999715
L6RANE1VA	New construction with nails (Airseal IC), ELV, 120V, Version A	•		662057994079
LED				
L6R15830VA	1500lm, 3000K (CRI 80), Version A	•		662057941202
L6R15835VA	1500lm, 3500K (CRI 80), Version A	•		662057941219
Trim Round				
L6RBW	Baffle Downlight, White with white flange			662057993980
L6RDD	Downlight, Clear diffuse with white flange			662057993997
L6RDW	Downlight, White with white flange			662057994000
LyteCaster 6" Accessories				
1956	Set of 4 Mounting Bar Clips			784197145132
VBE300	Vapor Barrier for 9" IC Box			784197343712
Trim				
1105CL	Reflector Alzak Cone Clear			662057679778
1176CH	Reflector Basic Cone Chrome			784197003517
1176WH	Trim, Basic Baffle White			662057672144



LytePoints Downlights

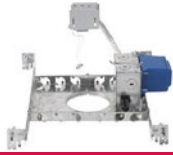

Housing



Trim



Housing



Trim



Catalogue Number	Description / Features	UPC
LytePoints 3¾"		
Housing		
300MRSPX	Remodeler Non-IC MR16 Magnetic Silent Pack	662057037196
Trim		
304CLX	Adjustable Cone Specular Clear	624563083418
305WHWX	MR16 Adjustable Baffle White	624563083319
375WHX	MR16 Adjustable Basic Baffle White	784197436094
378WHX	MR16 Adjustable Elbow White	784197436339
313STX	MR16 Adjustable Gimbal Brushed Steel	784197435707
313WHX	MR16 Adjustable Gimbal White	784197435714
394CHX	MR16 Basic Cone Chrome	624563154132
LytePoints 4¼"		
Housing		
502AICSX	PAR20 Frame-In Kit IC/AirSeal	624563217226
502X	V-Frame Frame-In Kit Non-IC	624563088406
Trim		
594CHX	Adjustable Alzak Cone PAR20 Chrome	624563116758
575WHX	Adjustable Step Baffle PAR20 White	624563088451
516WHX	Contour PAR20 White	624563088550
513WHX	Residence PAR20 White	624563088543



Track Lighting

Track Head LED



LT08



TH



Catalogue Number	Description / Features		UPC
CorePro LED Mini Cylinder			
	ELV Dimming		
LT08RWF830BKVA	900lm, Wide Flood (35°), 3000K (CRI 80), Black	•	190096041923
LT08RWF830WHVA	900lm, Wide Flood (35°), 3000K (CRI 80), White	•	190096041916
Track Head LED			
	1000lm, ELV / TRIAC (10%) Dimming		
TH10930NF1B	1000lm, 3000K (CRI 90), Narrow Flood (30°), 120V, Black	•	190096016495
TH10930NF1W	1000lm, 3000K (CRI 90), Narrow Flood (30°), 120V, White	•	190096016488
	3000lm, ELV / TRIAC (10%) Dimming		
TH30930F1B	3000lm, 3000K (CRI 90), Flood (36°), 120V, Black	•	190096016518
TH30930F1W	3000lm, 3000K (CRI 90), Flood (36°), 120V, White	•	190096016501
TH30930NF1B	3000lm, 3000K (CRI 90), Narrow Flood (22°), 120V, Black	•	190096016532
TH30930NF1W	3000lm, 3000K (CRI 90), Narrow Flood (22°), 120V, White	•	190096016525



6278WH



6320WH



8201WH

Catalogue Number	Description / Features	ENERGY STAR	DLC LISTED	UPC
LyteSpot PAR Ring				
6278WH	50W PAR20 White			784197627805
6282WH	75W PAR30S White			624563060259
Basic Track Head				
6320WH	Universal Lytespot White			624563019974
Par-Tech				
8201WH	Par-Tech Low Profile Adapter White			784197820107



851WH



55215WH



Monopoint



Gimbal Ring



Catalogue Number	Description / Features	UPC
LyteSpan	Domelite	
851WH	MR16 50W White	662057632612
	PAR Ring	
55215WH	250W PAR38 White	624563060242
55241WH	75W PAR30S Front Relamp White	624563030054
55242WH	250W PAR38 Front Relamp White	624563030078
	Round Monopoint	
6190BK	Black	784197619015
6190WH	White	784197619022
	Gimbal Ring	
9030NBK	PAR30 Black	662057905907
9030NWH	PAR30 White	662057905914
9038NBK	PAR38 Black	662057905938
9038NWH	PAR38 White	662057905945



LyteSpan Track



6048NWH



6049NWH



6050NWH



6054NWH

Catalogue Number	Description / Features	ENERGY STAR	DLC LISTED	UPC
LyteSpan	Plain Basic 1 Circuit Track with Dead End			
6004NBK	4' Black			784197594268
6004NWH	4' White			784197594275
6008NBK	8' Black			784197594282
6008NWH	8' White			784197594299
6012NWH	12' White			784197594312
	Live End			
6048NBK	Black			784197594589
6048NWH	White			784197594596
	Connectors			
6049NBK	Mini Coupler Black			784197594565
6049NWH	Mini Coupler White			784197594572
6050NWH	"L" Connector White			784197594473
6054NBK	In-Line Connector Black			784197594329
6054NWH	In-Line Connector White			784197594350
	Power Feed			
6063WH	Saddle Canopy Kit Power Feed White			784197606305



KEENE

Commercial Outdoor Lighting





The Keene outdoor lighting portfolio features contractor-friendly solutions that help make the most of your time and budget. Keene offers readily available and dependable luminaires suitable for a range of commercial application types.



Area & Canopy



AL



PT50

Catalogue Number	Description / Features	ENERGY STAR	DLC LISTED	UPC
Area Light LED				
150W				
AL150-NW-G1-AR-3-8-BZ	150W, 4000K (CRI 70), Arm mount, Type 3, 120-277V, Bronze			• 783352023971
AL150-NW-G1-AR-3-6-BZ	150W, 4000K (CRI 70), Arm mount, Type 3, 347V, Bronze			• 783352024015
AL150-NW-G1-AR-4-8-BZ	150W, 4000K (CRI 70), Arm mount, Type 4, 120-277V, Bronze			• 783352023995
AL150-NW-G1-AR-4-6-BZ	150W, 4000K (CRI 70), Arm mount, Type 4, 347V, Bronze			• 783352024039
200W				
AL200-NW-G1-AR-3-8-BZ	200W, 4000K (CRI 70), Arm mount, Type 3, 120-277V, Bronze			• 783352023988
AL200-NW-G1-AR-3-6-BZ	200W, 4000K (CRI 70), Arm mount, Type 3, 347V, Bronze			• 783352024022
AL200-NW-G1-AR-4-8-BZ	200W, 4000K (CRI 70), Arm mount, Type 4, 120-277V, Bronze			• 783352024008
AL200-NW-G1-AR-4-6-BZ	200W, 4000K (CRI 70), Arm mount, Type 4, 347V, Bronze			• 783352024046
Post Top LED				
Field Adjustable Wattage Selector, Twist Lock Receptical w/ Shorting Cap, Black				
PT50-WW-G1-T2-3-HV3-FAWS-TLRPC-BK	50W, 3000K (CRI 70), Type 3, 120-347V			• 783352026064
PT50-NW-G1-T2-3-HV3-FAWS-TLRPC-BK	50W, 4000K (CRI 70), Type 3, 120-347V			• 783352026088
PT50-WW-G1-T2-5-HV3-FAWS-TLRPC-BK	50W, 3000K (CRI 70), Type 5, 120-347V			• 783352026071
PT50-NW-G1-T2-5-HV3-FAWS-TLRPC-BK	50W, 4000K (CRI 70), Type 5, 120-347V			• 783352026095



GC40 / GC57



GC88

Catalogue Number	Description / Features	ENERGY STAR	DLC LISTED	UPC
Garage & Canopy LED				
40W				
GC40-NW-G1-SM-5-8-BZ	40W, 4000K (CRI 70), Type 5 Symmetric, 120-277V, Bronze			• 783352024251
GC40-NW-G1-SM-5-6-BZ	40W, 4000K (CRI 70), Type 5 Symmetric, 347V, Bronze			• 783352024275
57W				
GC57-NW-G1-SM-5-8-BZ	57W, 4000K (CRI 70), Type 5 Symmetric, 120-277V, Bronze			• 783352024268
GC57-NW-G1-SM-5-6-BZ	57W, 4000K (CRI 70), Type 5 Symmetric, 347V, Bronze			• 783352024282
88W				
GC88-NW-G1-SM-5-8-BZ	88W, 4000K (CRI 70), Type 5 Symmetric, 120-277V, Bronze			• 624563340115
GC88-NW-G1-SM-5-6-BZ	88W, 4000K (CRI 70), Type 5 Symmetric, 347V, Bronze			• 624563340122



A blue-tinted photograph of a brick building at night. The building has multiple windows and a covered entrance on the right. Three floodlights are mounted on the roof, casting a bright glow. The word "Floodlights" is written in large white letters across the center of the image.

Floodlights



FL



TF



BT10



Catalogue Number	Description / Features	UPC
General Purpose Flood LED		
FL150-NW-G1-T-FL-6-BZ	150W, 4000K (CRI 70), Yoke mount, 347V, Bronze	• 783352024237
FL300-NW-G1-T-FL-8-BZ	300W, 4000K (CRI 70), Yoke mount, 120-277V, Bronze	• 783352024190
FL300-NW-G1-T-FL-6-BZ	300W, 4000K (CRI 70), Yoke mount, 347V, Bronze	• 783352024244
LED Slim Flood		
TF10-NW-G1-K-FL-8-BZ	10W, 4000K (CRI 80), Yoke/Knuckle Mount, 120-277V, Bronze	• 783352025944
TF30-NW-G1-K-FL-8-BZ	30W, 4000K (CRI 80), Yoke/Knuckle Mount, 120-277V, Bronze	• 783352025951
TF50-NW-G1-K-FL-8-BZ	50W, 4000K (CRI 80), Yoke/Knuckle Mount, 120-277V, Bronze	• 783352025968
TF100-NW-G1-Y-FL-8-BZ	100W, 4000K (CRI 80), Yoke Mount, 120-277V, Bronze	• 783352025975
TF150-NW-G1-Y-FL-8-BZ	150W, 4000K (CRI 80), Yoke Mount, 120-277V, Bronze	• 783352025982
TF200-NW-G1-Y-FL-8-BZ	200W, 4000K (CRI 80), Yoke Mount, 120-277V, Bronze	• 783352025999
Mounting Adapter		
BT10	Universal slipfitter, converts yoke mount flood to tenon mount (fits 2 3/8" O.D. tenon), bronze finish	624290377736



Wallpacks



LPW7



LPW16



LPW32



PW

Catalogue Number	Description / Features	ENERGY STAR	DLC LISTED	UPC
LytePro LED Wall Sconce				
10W				
LPW7-G3-8-BZ	10W, 4000K (CRI 70), Type 2, 120-277V, Bronze			• 622252813858
LPW7-G3-8-DGY	10W, 4000K (CRI 70), Type 2, 120-277V, Dark Gray			• 622252813841
30W				
LPW16-G3-8-BZ	30W, 4000K (CRI 70), Type 3, 120-277V, Bronze			• 622252813872
LPW16-G3-8-DGY	30W, 4000K (CRI 70), Type 3, 120-277V, Dark Gray			• 622252813865
70W				
LPW32-G3-8-BZ	70W, 4000K (CRI 70), Type 3, 120-277V, Bronze			• 622252813896
LPW32-G3-8-DGY	70W, 4000K (CRI 70), Type 3, 120-277V, Dark Grey			• 622252813889
Low Profile Wall LED				
15W				
PW15-NW-G1-8-BZ	15W, 4000K (CRI 80), 120-277V, Bronze			• 783352024299
PW15-NW-G1-6-BZ	15W, 4000K (CRI 80), 347V, Bronze			• 783352024329
30W				
PW30-NW-G1-8-BZ	30W, 4000K (CRI 80), 120-277V, Bronze			• 783352024305
PW30-NW-G1-6-BZ	30W, 4000K (CRI 80), 347V, Bronze			• 783352024336
50W				
PW50-NW-G1-8-BZ	50W, 4000K (CRI 80), 120-277V, Bronze			• 783352024312
PW50-NW-G1-6-BZ	50W, 4000K (CRI 80), 347V, Bronze			• 783352024343
80W				
PW80-NW-G1-8-BZ	80W, 4000K (CRI 80), 120-277V, Bronze			• 624563340146
PW80-NW-G1-6-BZ	80W, 4000K (CRI 80), 347V, Bronze			• 624563340153



LWL



SWL



TW



WP30



WP50 / WP75

Catalogue Number	Description / Features	ENERGY STAR	DLC LISTED	UPC
LWL Wall Light LED				
LWL-WW-G2-PCB-1-BZ	12W, 3000K (CRI 80), 120V, Bronze, Button Photocell installed			783352025760
SWL Square Wall Light LED				
SWL-WW-G1-PCB-1-BZ	13W, 3000K (CRI 80), 120V, Bronze, Button Photocell installed			783352025777
Tall Wall Pack LED				
TW20-NW-G1-8-BZ	20W, 4000K (CRI 70), 120-277V, Bronze		•	783352024053
TW20-NW-G1-PCB-1-BZ	20W, 4000K (CRI 70), 120-277V, Bronze, Button Photocell installed		•	624563340139
Wall Pack LED				
30W				
WP30-NW-G1-8-BZ	30W, 4000K (CRI 70), 120-277V, Bronze		•	783352024060
WP30-NW-G1-6-BZ	30W, 4000K (CRI 70), 347V, Bronze		•	783352024091
50W				
WP50-NW-G1-8-BZ	50W, 4000K (CRI 70), 120-277V, Bronze		•	783352024077
WP50-NW-G1-6-BZ	50W, 4000K (CRI 70), 347V, Bronze		•	783352024107
75W				
WP75-NW-G1-8-BZ	75W, 4000K (CRI 70), 120-277V, Bronze		•	783352024084
WP75-NW-G1-6-BZ	75W, 4000K (CRI 70), 347V, Bronze		•	783352024114





Specialty



DTD40



BL



VCXL



VWXL



P105A

Catalogue Number	Description / Features	ENERGY STAR	DLC LISTED	UPC
Dusk to Dawn LED				
DTD40-NW-G3-AR-5-TL-RPC-1-GY3S	40W, 4000K (CRI 70), Arm mount, Type 5, 120V, Twist lock receptacle + Photocell, Grey			• 624563339836
DTDARMGY3S	Mounting arm with hardware, 1.5" dia steel, gray finish			783352024145
LED Commercial Bollard				
BL25-NW-G1-5-8-BZ	25W, 4000K (CRI 70), Type 5 Symmetrical, 120-277V, Bronze finish			• 624563340306
RoughLyte LED				
VCXL-14-NW-G1-8	Ceiling mount, 14W, 4000K (CRI 70), 120-277V			• 783352024770
VWXL-14-NW-G1-8	Wall mounted, 14W, 4000K (CRI 70), 120-277V			• 783352024787
Photocontrols				
P105A	120V Button Photocell			190096001835

HADCO

Decorative Outdoor Lighting



Hadco landscape lighting solutions blend craftsmanship with optical performance to provide a sense of security and beauty in parks, residential, or commercial settings.



BL9



IL9



TC152-12TP

Low Voltage



Catalogue Number	Description / Features	UPC
FlexScope BL9 LED		
BL9DW-AS7	Low Voltage 9W Bullet Lighting, 3000K, Black, Stake Mount	783352020802
BL9DW-HS7	Low Voltage 9W Bullet Lighting, 3000K, Bronze, Stake Mount	783352020819
FlexScope IL9 LED		
IL9DW-A	Low Voltage 9W Inground Lighting, 3000K, Black	783352021588
FlexScope Transformer		
TC152-12TP	Transformer for Low Voltage output, Voltage Control Switch (Low =11.5V, High=12.5V), Line voltage amperage draw: 150VA = 0.9 AMP, integral timer and photocell, 50/60Hz input	783352015044

interact Pro

Connected Wireless Lighting





Interact Pro is an intuitive app and portal that delivers the power of IoT connected lighting for up to 200 light points per Gateway. This completely wireless system instantly connects to smart Interact Ready products, including Philips LED lamps, sensors, wall-switches and Luminaires by Signify. Data insights from light points can be leveraged for service contracts via alerts on light failures, and also allows users to optimize energy usage and create light schemes.

Application Areas

Ideal applications for the Interact Pro connected lighting system include:

- Tenant fit out offices
- Small to medium retail stores
- Municipal buildings
- Small industry (for example a small workshop or warehouse)
- Retail banks
- Schools
- Micro hospitals

Interact Pro can connect up to 200 light points per wireless gateway to the cloud. Multiple gateways can be used in one project when the number of light points exceeds 200, or in cases where the wireless signal cannot propagate due to building materials such as steel reinforced concrete. Each gateway would be used to control a logical area such as a floor or discrete part of the building. Typically, one wireless gateway can cover an area of up to 11,000 ft² (1,000 m²) or larger. In buildings with lower lighting requirements, warehousing for example, up to 110,000 ft² (10,000 m²) may be connected.

Recommended System Architecture

On Site Requirements		Required	
Interact Pro Wireless Gateway		Minimum 1	
Ethernet cable connection to router with internet connection		1 per Gateway (provided by customer)	

	Components	Per Gateway	Per Group / Zone
System	Interact Pro Wireless Sensors & Switches	50 (max 30 sensors)	5 (max)
	Interact Ready Light points	200	16-25*
	Groups / zones	64 (max)	-
Software	Scenes	128	16
	Schedules	16	-
	Users	Unlimited	-

* Recommend limit, no software limitation

System Components

The combination of hardware components and system specific firmware and software defines the Interact Pro system.

All key components are future proof, via regular firmware and software updates that are pushed over the air (OTA). This process ensures the stable and secure operation of the system and enables the addition of new features and functionality without requiring the customer to install new hardware.

View the [Interact Pro Design Guide](#) for full details.

For more information please visit www.interact-lighting.com/pro



Wireless Gateway

The basis of the lighting system connects the system to the cloud via an IT network connected to the internet. The wireless gateway connects with the light points through a ZigBee® mesh network.



Wireless Occ. Sensors

Senses the presence of people in an area with lighting and triggers the switching through ZigBee®. Daylight dependent regulation is possible with a multi-sensor that supports light sensing and occupancy detection.



interact ready.

Light points

Interact Ready lamps or luminaires equipped to act as nodes within the Zigbee® mesh network. A full list of available Interact Ready products can be found at: interact-lighting.com/pro



Wireless Switch

This kinetic switch enables the manual control of the lighting in an area, for example switching on and off, dimming and scene selection wirelessly.



Portal

A cloud-based website for design, installation, commissioning, operation, or management. Access rights of the users determine feature visibility.



App

Software installed on a smart device that is used for commissioning and operation.



Gateway





Switch



Occupancy Sensor



Occupancy Multi Sensor

Catalogue Number	Description / Features	 	UPC
Interact Pro Wireless Gateway			
LCN1840/05	Gateway (North America)	NLC	046677476335
Interact Pro Wireless Switch			
UID8451/10	On/Off/Dim Switch 2 button	NLC	046677455439
Interact Pro Wireless Sensors			
476184	OCC SENSOR IA CM IP42 WH 10/1	NLC	046677476182
476192	OCC MULTI SENSOR IA CM WH 10/1	NLC	046677476199



FluxGrid



FluxPanel



Catalogue Number	Description / Features	UPC
FluxGrid LED	See 22 for full product family	
2FGG43L840-4-D-UNV-DIM-IAP	2×4', 4300lm, 4000K (CRI 80), UNV, 0-10V Dimming	• 784197655457
FluxPanel LED	See 20 for full product family	
1FXP38L835-4-DS-UNV-DIM-IAP	1×4', 3800lm, 3500K (CRI 80), UNV, 0-10V Dimming	• 784197642211
1FXP38L840-4-DS-UNV-DIM-IAP	1×4', 3800lm, 4000K (CRI 80), UNV, 0-10V Dimming	• 784197642280
2FXP38L835-2-DS-UNV-DIM-IAP	2×2', 3800lm, 3500K (CRI 80), UNV, 0-10V Dimming	• 784197642259
2FXP38L840-2-DS-UNV-DIM-IAP	2×2', 3800lm, 4000K (CRI 80), UNV, 0-10V Dimming	• 784197642242
2FXP43L835-4-DS-UNV-DIM-IAP	2×4', 4300lm, 3500K (CRI 80), UNV, 0-10V Dimming	• 784197642228
2FXP43L840-4-DS-UNV-DIM-IAP	2×4', 4300lm, 4000K (CRI 80), UNV, 0-10V Dimming	• 784197642235



4RNIP / 6NIP



MasterConnect T8



MasterConnect T8 U

Catalogue Number	Description / Features	ENERGY STAR	DLC LISTED	UPC
UniFrame	Please see "UniFrame Downlights" on page 34 for full selection of compatible products			
3RNIP	UniFrame, 3" Round, New Construction (Non-IC), UNV	•		784197666132
3SNIP	UniFrame, 3" Square, New Construction (Non-IC), UNV	•		784197666194
4RNIP	4" Round, New Construction (Non-IC), UNV	•		190096017515
6RNIP	6" Round, New Construction (Non-IC), UNV	•		190096017553
Philips MasterConnect	2' T8 LED Lamp			
537258	8T8/24-830/IF11/MAScon IA 10/1			046677537258
537266	8T8/24-835/IF11/MAScon IA 10/1	•		046677537265
537274	8T8/24-840/IF12/MAScon IA 10/1	•		046677537272
537282	8T8/24-850/IF12/MAScon IA 10/1	•		046677537289
	4' T8 LED Lamp			
537183	14T8/48-835/IF20/MAScon IA 10/1	•		046677537180
537191	14T8/48-840/IF21/MAScon IA 10/1	•		046677537197
537209	14T8/48-850/IF21/MAScon IA 10/1	•		046677537203
	U-Bent T8 LED Lamp			
537225	15T8/24-835/IF20-6U/MAScon IA 10/1	•		046677537227
537233	15T8/24-840/IF21-6U/MAScon IA 10/1	•		046677537234
537241	15T8/24-850/IF21-6U/MAScon IA 10/1	•		046677537241

interact Pro

The simple way to connected lighting

This game-changing wireless connected lighting system works with Interact Ready light sources that instantly connect to the Interact Pro app and portal.

No extra cabling or IT support is required, so it's easy to install and commission jobs faster than ever before.

www.interact-lighting.com/pro



PHILIPS

Lamps

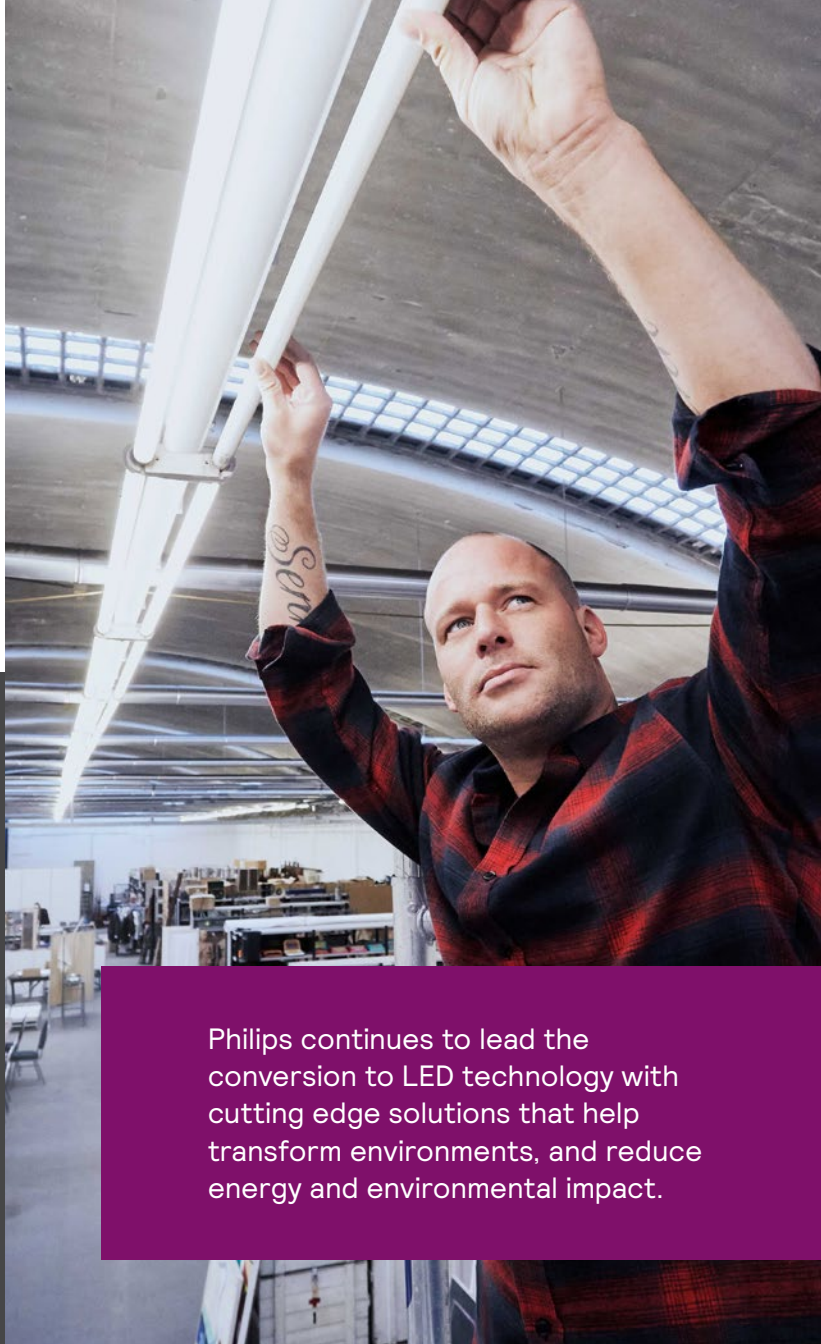
A man in a red and black plaid shirt is working on a long, white LED light fixture in a warehouse or industrial setting. He is looking up at the fixture, and his hands are positioned to adjust or install it. The background shows a large, open space with various equipment and materials.

Philips continues to lead the conversion to LED technology with cutting edge solutions that help transform environments, and reduce energy and environmental impact.

MasterClass

For every project where exceptional, high-quality lighting is required. The MasterClass line of LEDs meets or exceeds applicable industry energy efficiency requirements, featuring improved lifespan over traditional incandescent bulbs and warranties with broad product ranges.

- Up to 80% energy savings¹
- Expanded product breadth, including additional beam angles and shapes, when compared to incandescent bulbs
- Lifetime of up to 70,000 hours and up to 7-year limited warranty³
- High colour rendering index (CRI) 90+
- Superior polycarbonate material

CorePro

For every job requiring efficiency, value and uncompromising quality, these LED lamps are perfect for basic lighting needs across a wide range of applications. The CorePro line of LEDs meet industry efficiency standards and minimize maintenance costs for quick payback.

- Up to 80% energy savings¹
- More choices with our expanded portfolio
- Lower maintenance costs¹
- Lifetime of 15,000+ hours²
- Colour rendering index (CRI) 80+





InstantFit LED		UniversalFit LED	MainsFit LED	MasterConnect LED	
UL Type A	UL Type C	UL Type A	UL Type B	Smart LED	
<p>Achieve the fastest ROI with a plug & play solution that works with existing ballasts</p> <ul style="list-style-type: none"> • Quick and simple installation • No rewiring / recertification required • 80% compatibility with fluorescent ballasts 		<p>Plug & play solution with the widest range of compatibility with existing ballasts</p> <ul style="list-style-type: none"> • Many Philips Type A lamps double as Type C when paired with LED drivers that last longer than fluorescent ballasts • Expanded performance for dimming and efficacy 	<p>Works with the Interact Pro wireless connected lighting system</p> <ul style="list-style-type: none"> • Quick and simple installation • No rewiring / recertification required • 80% compatibility with fluorescent ballasts including Magnetic (T12) and electronic ballasts 	<p>Bypass ballasts, thereby eliminating compatibility & maintenance issues</p> <ul style="list-style-type: none"> • No ballast required • Compatible with emergency backup lighting inverters (Bodine ELI-S series) 	<p>Works with the Interact Pro wireless connected lighting system</p> <ul style="list-style-type: none"> • Personalized control of lighting levels • Grouping for wireless dimming • Integrates with wireless occupancy / daylight harvesting sensors

philips.ca/instantfit
philips.ca/mainsfit
philips.ca/interactready

1. When compared to traditional incandescent bulbs.
 2. Tested to B50 L70 requirement. LED lifetime means the length of time (in hours) until half of the LED light sources maintain at least 70% of their initial lumen output (B50, L70).
 3. See www.signify.com/warranties for details.



MasterClass T5HO

MasterClass T8

CorePro T8

TLED

Order Code	Product Name	Description / Features	ENERGY STAR	DLC LISTED	UPC
MasterClass LEDtube InstantFit T5 HO, UL Type A					
467142	24T5HO/46-840/IF35/P/DIM 10/1	24W, 4', 3500lm, 4000K (CRI 82)			• 046677467142
467159	24T5HO/46-850/IF35/P/DIM 10/1	24W, 4', 3500lm, 5000K (CRI 82)			• 046677467159
MasterClass LEDtube InstantFit T8, UL Type A/C					
541821	7T8/MAS/24-835/IF10/P 10/1	7W, 2', 1050lm, 3500K (CRI 82)			• 046677541828
541839	7T8/MAS/24-840/IF11/P 10/1	7W, 2', 1150lm, 4000K (CRI 82)			• 046677541835
541847	7T8/MAS/24-850/IF11/P 10/1	7W, 2', 1150lm, 5000K (CRI 80)			• 046677541842
539866	8.5T8/MAS/36-835/IF13/P 10/1	8.5W, 3', 1300lm, 3500K (CRI 82)			• 046677539863
539874	8.5T8/MAS/36-840/IF14/P 10/1	8.5W, 3', 1400lm, 4000K (CRI 82)			• 046677539870
539882	8.5T8/MAS/36-850/IF14/P 10/1	8.5W, 3', 1400lm, 5000K (CRI 80)			• 046677539887
473982	9.5T8/MAS/48-835/IF15/P 10/1	9.5W, 4', 1500lm, 3500K (CRI 82)			• 046677473983
473990	9.5T8/MAS/48-840/IF16/P 10/1	9.5W, 4', 1600lm, 4000K (CRI 82)			• 046677473990
474007	9.5T8/MAS/48-850/IF16/P 10/1	9.5W, 4', 1600lm, 5000K (CRI 80)			• 046677474003
CorePro LEDtube InstantFit T8, UL Type A/C					
553222	10T8/COR/48-835/IF15/G 10/1	10W, 4', 1500lm, 3500K (CRI 80)			• 046677553227
541986	10T8/COR/48-840/IF16/G 25/1	10W, 4', 1600lm, 4000K (CRI 80)			• 046677541989
541994	10T8/COR/48-850/IF16/G 25/1	10W, 4', 1600lm, 5000K (CRI 82)			• 046677541996
470104	14T8/PRO/48-835/IF20/G 10/1 FB	14W, 4', 2000lm, 3500K (CRI 82)			• 046677452759
470112	14T8/PRO/48-840/IF21/G 10/1 FB	14W, 4', 2100lm, 4000K (CRI 82)			• 046677453251
470120	14T8/COR/48-850/IF21/G 10/1	14W, 4', 2100lm, 5000K (CRI 82)			• 046677452483



UniversalFit T8

MainsFit T8

MainsFit T8 347V



Order Code	Product Name	Description / Features	UPC
CorePro LEDtube UniversalFit T8, UL Type A			
539927	16T8/LED/48-840/UF18/G 10/1	16W, 4', 1800lm, 4000K (CRI 80)	046677539979
539980	16T8/LED/48-850/UF18/G 10/1	16W, 4', 1800lm, 5000K (CRI 80)	046677539986
MasterClass LEDtube MainsFit T8, UL Type B			
532689	12T8/PER/48-835/BB17/G 10/1 FB	12W, 4', 1700lm, 3500K (CRI 80)	• 046677532680
532697	12T8/PER/48-840/BB18/G 10/1 FB	12W, 4', 1800lm, 4000K (CRI 80)	• 046677532697
CorePro LEDtube MainsFit T8, UL Type B			
471755	16.5T8/COR/48-835/MF20/G 10/1	16.5W, 4', 2000lm, 3500K (CRI 80)	• 046677471750
471763	16.5T8/COR/48-840/MF21/G 10/1	16.5W, 4', 2100lm, 4000K (CRI 80)	• 046677471767
554675	16.5T8/COR/48-835/MF20/G/347V 25/1	16.5W, 4', 2100lm, 3500K (CRI 80), 347V	• 046677554675
554683	16.5T8/COR/48-840/MF21/G/347V 25/1	16.5W, 4', 2100lm, 4000K (CRI 80), 347V	• 046677554682



interact ready.



interact ready.

MasterConnect T8

MasterConnect T8 U



Order Code	Product Name	Description / Features	UPC
MasterConnect LEDtube InstantFit T8			
537258	8T8/24-830/IF11/MAScon IA 10/1	8W, 2', 1150lm, 3000K (CRI 80)	046677537258
537266	8T8/24-835/IF11/MAScon IA 10/1	8W, 2', 1150lm, 3500K (CRI 80)	• 046677537265
537274	8T8/24-840/IF12/MAScon IA 10/1	8W, 2', 1200lm, 4000K (CRI 80)	• 046677537272
537282	8T8/24-850/IF12/MAScon IA 10/1	8W, 2', 1200lm, 5000K (CRI 80)	• 046677537289
537183	14T8/48-835/IF20/MAScon IA 10/1	14W, 4', 2000lm, 3500K (CRI 82)	• 046677537180
537191	14T8/48-840/IF21/MAScon IA 10/1	14W, 4', 2100lm, 4000K (CRI 82)	• 046677537197
537209	14T8/48-850/IF21/MAScon IA 10/1	14W, 4', 2100lm, 5000K (CRI 82)	• 046677537203
MasterConnect LEDtube InstantFit T8 U-Bent			
537225	15T8/24-835/IF20-6U/MAScon IA 10/1	15W, 2' U-Bent, 2000lm, 3500K (CRI 80)	• 046677537227
537233	15T8/24-840/IF21-6U/MAScon IA 10/1	15W, 2' U-Bent, 2100lm, 4000K (CRI 80)	• 046677537234
537241	15T8/24-850/IF21-6U/MAScon IA 10/1	15W, 2' U-Bent, 2100lm, 5000K (CRI 80)	• 046677537241

interact ready.



A19





BR30



GU10



MR16

Order Code	Product Name	Description / Features	 	UPC
CorePro Bulbs				
550434	8.8A19/PER/927/P/E26/DIM 6/1FB T20	A19, 8.8W, 800lm, 2700K (CRI 90)	•	046677550431
550442	8.8A19/PER/930/P/E26/DIM 6/1FB T20	A19, 8.8W, 800lm, 3000K (CRI 90)	•	046677550448
CorePro Spots & Reflectors				
473843	11BR30/827/DIM	BR30, 11W, 650lm, 2700K (CRI 80)		046677473846
468140	4GU10/LED/930/F35/DIM/G/120V 4/1BC	GU10, 4W, 380lm, 3000K (CRI 90)	•	046677468149
533125	7.3MR16/LED/830/F25/DIM 12V 10/1FB	MR16, 7.3W, 515lm, 3000K (CRI 82)	•	046677533120
533158	7.3MR16/LED/830/F35/DIM 12V 10/1FB	MR16, 7.3W, 515lm, 3000K (CRI 82)	•	046677533151
469998	4.4PAR16S/LED/930/F40/DIM/G/120V 4/1BC	PAR16, 4.4W, 800lm, 2700K (CRI 90)		046677469993
471144	7PAR20/LED/F40/830/E26/GL/DIM 120V 6/1	PAR20, 7W, 500lm, 3000K (CRI 80)	•	046677471149
471136	7PAR20/LED/827-822/F40/GL/DIM 1PK 6/1	PAR20, 7W, 500lm, 2700 WGK (CRI 80), WG	•	046677471132
529743	10PAR30L/LED/830/F40/DIM/ULW/120V 6/1FB	PAR30L, 10W, 850lm, 3000K (CRI 80)	•	046677529741
529677	12PAR38/LED/830/F40/DIM/ULW/120V 6/1FB	PAR38, 12W, 900lm, 3000K (CRI 80)	•	046677529673



PAR16S



PAR20



PAR30L



PAR38

ADVANCE

by  Signify

Advance Express Programming a LED driver has never been simpler

Advance Express is more than just LED Drivers. It is a program for our distributor partners to help their customers address luminaire component failure in the field by providing an LED driver programming service.

Learn more online:

signify.com/AdvanceExpressCA



Definitions

Colour Temperature (K)

The colour of light output by a light source is referenced as correlated colour temperature (CCT) and is measured in Kelvins (K).



2700K

3000K

4000K

5000K

Colour Rendering Index (CRI)

The effect a light source has on colour appearance is expressed as CRI, on a scale of 0–100. Natural outdoor light is used as a standard with a CRI of 100.



CRI 60

CRI 80

 CRI 90

Lumens (lm)

The measurement total light output by a light regardless of direction.

Candela (cd)

The measurement of light intensity emitted by a light source in a particular direction.



The **DesignLights Consortium® (DLC)** promotes high-quality, energy-efficient lighting products in collaboration with utilities and energy efficiency program members, manufacturers, lighting designers, and federal, state, and local entities.

DLC Premium is a higher-performance classification for luminaires and retrofit kits. Products with DLC Premium classification meet higher efficacy and lumen maintenance requirements.

A **Network Lighting Controls (NLC)** consists of an intelligent network of individually addressable luminaires and control devices, allowing for application of multiple control strategies, programmability, building- or enterprise-level control, zoning and rezoning using software, and measuring and monitoring. They can save 35% or more of lighting energy use in commercial buildings while providing a host of additional capabilities and benefits.



Protected from total dust ingress. Protected from low pressure water jets from any direction.



Protected from total dust ingress. Protected from high pressure water jets from any direction.



Protected from total dust ingress. Protected from immersion between 15 centimeters and 1 meter in depth.



Protected from total dust ingress. Protected from long term immersion up to a specified pressure.



The **ENERGY STAR**® symbol is the internationally recognized and trusted mark of high efficiency. ENERGY STAR certified products meet strict technical specifications for energy performance—tested and certified against a number of standards such as ANSI, IESNA, cUL, NEMA, etc.



A wet location is one where water may drip, splash, or flow on or against electrical equipment. This icon indicates that the fixture was engineered so that water cannot enter or accumulate in the wireway, lampholders or other electrical parts.



NSF International is an accredited, independent third-party certification body that tests and certifies products to verify they meet these public health and safety standards.

Brand Line Card

IoT Platform

interact

A secure IoT platform with software applications that deliver benefits to professional customers across a variety of business verticals.

Indoor Luminaire Brands

 **LEDALITE**

by @ignify

Strikingly aesthetic, unique and bold indoor lighting to make a rich statement in professional, commercial and institutional spaces.

LIGHTOLIER

by @ignify

Impactful, reliable track and downlighting solutions with uncompromising quality for professional and commercial spaces.

Day-Brite

CFI

by @ignify

Versatile commercial and industrial indoor lighting solutions built for functionality and dependable performance throughout the product life cycle.

Lamps & Controls

PHILIPS

Global lighting leader in LED and conventional lamps for every application.

Outdoor Luminaire Brands

LUMEC

by @ignify

Contemporary outdoor lighting that blends modern and traditional style with leading-edge engineering to provide functional elegance for urban and roadway spaces.

 **GARDCO**

by @ignify

Architecturally relevant, configurable and functional lighting solutions that enhance and complement outdoor spaces.

HADCO

by @ignify

Pedestrian and Landscape lighting solutions that blend craftsmanship with optical performance to provide a sense of security and beauty in parks and other public or residential settings.

KEENE

by @ignify

Contractor-friendly outdoor lighting solutions that help make the most of your time and budget.

Specialty

 **COLORKINETICS**

Dynamic and intelligent lighting for architectural indoor, outdoor and entertainment spaces.

Electronics

ADVANCE

by @ignify

Offering a full range of reliable and robust ballasts, LED drivers and lighting components for the electrical wholesaler and OEM channels.

bodine

Innovative emergency lighting components / unit equipment designed for safety.

Signify proudly markets the best lighting brands in the world.

Learn more about the vast array of lighting solutions available from Signify. Visit www.signify.com



